

HILOTHERM[®]



Clinic

Operating Instructions



Type HT02

Revision 2020-01-23
English

HILOTHERM GmbH
Wittumweg 38
D-88260 Argenbühl-Eisenharz
Tel. +49 / 75 66 / 9 11 99

CE **0123**

Table of Contents

1. General Description

- 1.1 Purpose
- 1.2 Fields of Application
- 1.3 Indications and Contraindications
- 1.4 Requirements for Operator
- 1.5 Machine Description

2. Safety Instructions

- 2.1 General Safety Instructions
- 2.2 Hazard Instructions
- 2.3 Electromagnetic Compatibility
- 2.4 Ambient Conditions

3. Startup Procedure

- 3.1 Function Check
- 3.2 Positioning the Machine
- 3.3 Switching on for the first time and after changing water
- 3.4 Filling and Switching on
- 3.5 Setting Temperature
- 3.6 Connecting the Cuffs
- 3.7 Stopping
- 3.8 Malfunctions
- 3.9 Menu

4. Cleaning and Disinfection

- 4.1 General
- 4.2 Machine Surface
- 4.3 Cuffs

5. Technical Service and Maintenance

- 5.1 Replacing the Water Filter and Water Exchange
- 5.2 Cleaning the Heat Exchanger
- 5.3 Greasing the Plug Connections
- 5.4 Technical Service
- 5.5 Safety Related Inspections
- 5.6 Liability
- 5.7 Warranty

6. Storage, Transport, Disposal

- 6.1 Storage
- 6.2 Transport
- 6.3 Disposal

7. Technical Data

- 7.1 Technical Data
- 7.2 Icons
- 7.3 Safety Standard
- 7.4 Errors and Troubleshooting

8. Accessories and Spare Parts

9. Cuffs

- 9.1 Variants and Material Properties
- 9.2 Warnings
- 9.3 Field of Application
- 9.4 Risk Classification
- 9.5 Description of Application
- 9.6 Storage and Transport
- 9.7 Disinfection, Cleaning and Drying
- 9.8 Checkup
- 9.9 Packaging
- 9.10 Sterilisation

10. Annex

- A Guidelines and Manufacturer's Declaration
- B Declaration of Conformity



Before putting the Hilotherapy system into operation, carefully read the operating instructions. Pay special attention to the instructions labelled **Caution** and **Warning**.

Caution describes a situation leading to possible damage to the device or the attached modules.

Warning describes a situation leading to possible damage to persons.

1. General Description

1.1 Purpose

The mobile Hilotherapy system HT 02 is used for treating, alleviating and compensating localised injuries, diseases and their after-effects by means of a mild and constant cold. The temperature can be individually adjusted from + 10°C to + 35°C (+38°C). Electronically controlled sensors maintain the set temperatures at a constant level. The time until the device reaches the set temperature depends on the ambient temperature, and the size of the connected cuffs. With ambient temperatures of more than 25°C and big cuffs it could happen, that a set temperature of 15°C will not be reached. The Hilotherapy system is not suitable for reducing a patient's core body temperature (hypothermia).

1.2 Fields of Application

The Hilotherapy system may be used in various medical areas in the acute phase as well as the remodelling phase, and can effectively help chronically ill patients (e.g. with rheumatism, arthrosis, migraine).

Fields of application

Surgery:	Microsurgery, plastic surgery, vascular surgery, orthopaedics, trauma surgery, oral and maxillofacial surgery, oral surgery, oral implant surgery, ENT medicine, dermatologic surgery etc.
Sports medicine / Functional rehabilitation / Physiotherapy:	Mobility improvement, pain reduction, muscle relaxation, distortions, muscle strains, muscle tears, sprains, tendon inflammations, bruises, oedemas
Rheumatology:	Inflammatory rheumatism, Algodystrophic syndrome, Ischialgia
Other:	Dermatology (laser treatment, liposuction, wrinkle injection, photodynamic therapy), emergency medicine, fever, migraine and tension headache

Recommended temperature settings

Body part	Temperature range
Face	16 – 19°C
Head, neck	15 – 20°C
Breast, torso	18 – 21°C
Extremities	15 – 18°C (with bandages, as of 10°C possible)

All indicated temperatures are tested reference values and recommendations only.

Warning: Do not provoke tissue temperatures below 15 °C.

Duration of application

In general: cool as long as possible. The patient must decide according to his/her own sensation, he/she has to feel comfortable.

1.3 Indications and Contraindications

Indications for Hilotherapy

The indications for the use of hilotherapeutic measures are based on the ideas of the physiological mode of action of cold applications. The cold-induced adaptation processes, which occur on several levels in an interlinked manner, can be assigned to two principles of action: Depending on the temperature of the cold medium and the application time, more initial effects are being relayed with regard to vasomotion, pain and α - γ -motor neuron activity. A longer period of temperature decrease exposes subjacent structures and layers of tissue to the direct cold effect. Thus, the re-warming period varies accordingly.

Important factors in the intensity of the local and systematic effects of a cold stimulus are - besides the temperature and duration of the application - the physical properties of the cold medium, the initial skin temperature and its thermal conductivity as well as the area of the body and the size of the application area. The significance of this distinction lies in the necessity to clearly differentiate between the various forms of cold applications and levels of cooling and to apply them according to the findings and in a purpose-oriented manner.

For disease patterns with an emphasis on analgesic and muscle tone reducing therapy, the hilotherapeutical procedures are essential elements in pre-treatment or interval treatment.

Contraindications of Hilotherapy

Regarding contraindications, we also have to differentiate between „cold“ and „ice-cold“.

With consideration to the primary disease, the contraindications are put into perspective according to the levels of cold. Some diseases, for which the application of ice or comparable media is contraindicated, can be effectively treated with somewhat milder forms of cold. **All forms of cold applications are considered to be contraindicated for the emergence of cryoglobulin anaemia, cold haemagglutination and cold urticaria /cold contact urticaria caused by histamine release.**

Also contraindicated for Hilotherapy are diseases from the range of functional circulatory disorders (e.g. M. Raynaud), severe arterial obstructions, pronounced sensibility disorders and trophic tissue lesions. Provided adequate precautions are taken, mild cold stimuli can be applied for arterial circulatory disorders, mild forms of sensibility disorders and for patients with angina pectoris.

Caution: In patients with compartment syndrome, it is absolutely required to make sure the cuffs are applied without compression to avoid accelerating the already existing pressure increase and the accompanying perfusion disorder.

1.4 Requirements for Operator

Operation of the Hilotherapy system is simple and can be carried out by nursing staff or by the patients themselves. However, the application should be supervised by qualified medical personnel.

The operators shall familiarise themselves with the operating instructions and the device before initial operation. The application of the cuff in particular must be carried out with care.

1.5 Machine Description

The Hilotherapy system HT 02 is a transportable device for localised, professional cold treatment. It distinguishes itself by its simple handling and ease of operation.

The temperature setting is adjustable from + 10°C to + 35°C (+38°C)

The device is designed for continuous duty.

Basically, the Hilotherapy system consists of the following components:

Cooling and heating unit	The cooling and heating units serve to precisely control and maintain the temperature of the distilled water according to the chosen values.
Control unit	Through the device's sensors, the control unit acquires the current data and records them. It also controls the machine's processes. The desired temperature values are entered via the keys (pos. 04).
Display	The display (pos. 03) shows the set values and the current operating condition.

Cuffs

The cuffs transfer the cold / heat to those body regions to be treated by pumping distilled water at a certain temperature through the cuffs.

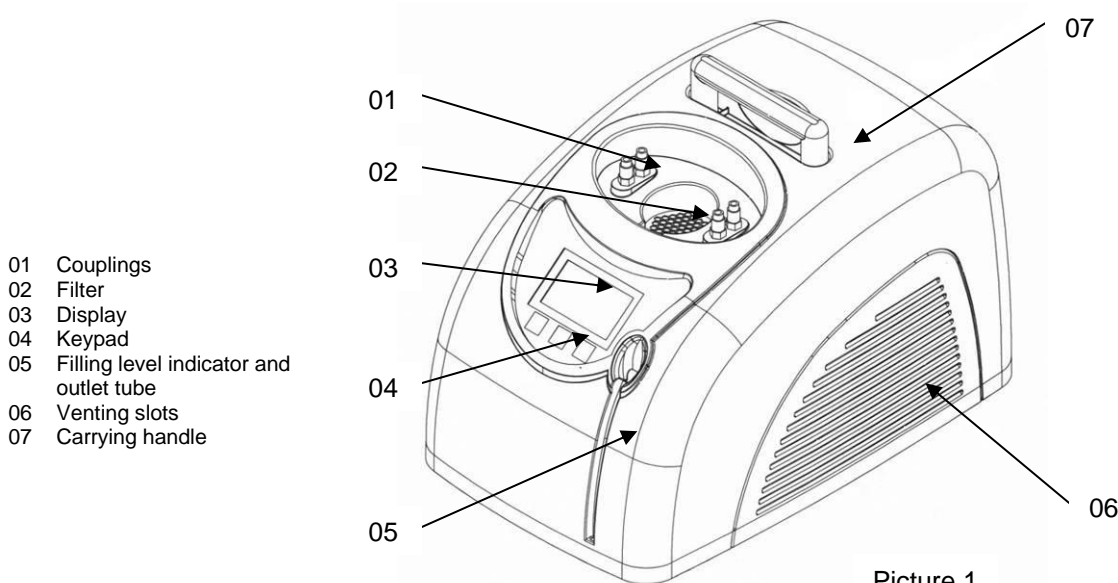

2. Safety Instructions

2.1 General Safety Instructions

- Before machine startup, the operator has to check if the device and the application parts are in a proper state.
- The therapeutical system always consists of a Hilotherapy device, duo hose and cuff(s).
- Use and connect only the original Hilotherapy devices and cuffs.
- In the shut down state, large cuffs (due to the high conductivity of water) can result in intended changes of body temperature (cooling in the case of heat treatment, warming up in the case of cold treatment). If the proper procedure cannot proceed due to failures, the cuff has to be removed.
- During treatment, especially when using several or large cuffs, the patient's body temperature should be monitored.
- The Hilotherapy system must not be used within an incubator.
- The cuffs may be damaged by sharp objects.
- The proper flow through the cuff channels may be obstructed by folding or compressing the cuffs.
- The flow through the tubing may be obstructed by kinks.
- Only fill up the tank with demineralized water.
- When filling up the tank with demineralized water, disconnect the device from the mains.
- Do not cover the venting slots on the sides.
The device may only be operated when positioned on a level and flat surface.
- The device may only be used when all units and displays are working properly.
- In case of failures, switch the device off immediately. Only after the failure condition was rectified, the machine may be used again. Please inform the manufacturer of any kind of critical or unclear errors.
- Maintenance interfaces and interfaces used for data transfer may not be used when a patient is attached to the device.
- **Warning!** It is not permitted to modify the device.

2.2 Hazard Instructions

- Do not open the housing.
- Prior to maintenance, disconnect the device from power supply.

- Machine maintenance may only be carried out by a qualified service technician.
- The AC voltage source must comply with the data given on the type plate attached to the back of the machine.
- The Hilotherapy system may only be connected to the mains using a reliable protective earth conductor. Do not use the system if the functionality of the external protective earth conductor is in doubt.
- To ensure fire protection, make sure when replacing the fuses that only the same type of fuses with the same nominal values are used (refer to type plate).

2.3 Electromagnetic Compatibility

In electrical medical appliances, particular attention is to be given to the electromagnetic compatibility (EMC), that is the device is to be installed and commissioned according to the EMC-directions contained in this operation instructions (please see instruction and manufacturer's declaration in the annex).

Portable and mobile radio communication devices may interfere with the operation of medical appliances.

Warning: The Hilotherapy system should not be operated next to / on top of other appliances. However, should this be necessary, the Hilotherapy system must be closely observed to ensure safe operation.

2.4 Ambient Conditions

The ambient temperatures for safe operation are between + 10 °C and + 26 °C.

If the ambient temperature is higher, the vested cooling capacity can not be provided.

If the device has been subjected to temperatures far beyond the indicated temperature range, let the device cool off until it has reached room temperature, before starting it again.

Protect the device against excessive heat, dust and direct exposure to the sun.

The air humidity in the room should not exceed 70%. Higher humidity can lead to condensation on the hoses and cuffs.

Caution: Accumulation of condensed water can lead to slipping on the floors. If this is recognized, appropriate safety measures must be initiated

Warning: The Hilotherapy device is not intended for use in highly explosive environments and must be kept away from flammable gases and liquids.

3. Startup Procedure

3.1 Function Check

Before taking the Hilotherapy system into operation, make sure the device and the applied parts (cuffs) are free of damage (see chapter 2, Safety Instructions).

Caution: The device shall only be put into operation when undamaged.

3.2 Positioning the Machine

- The Hilotherapy device shall be placed on a level, flat and hard surface.
- Position the device such that the air ventilation is not impeded.
- Observe a minimum distance to other appliances or furniture of 20 cm on the sides and 10 cm on the top of the device.
- The device must be positioned so that it is easy to disconnect it from the power supply.
- Please ensure that the machine ventilation is not directed towards the patient.

3.3 Switching on for the First Time and after Changing Water

Caution: When operating for the first time or after changing water it is necessary to bleed the air from the pump system before switching on the Hilotherapy device.

- To bleed insert the de-airing set with plug-in nozzle into one of the couplings on the front.
- Allow air to escape with the syringe.
- Remove de-airing set.



Caution: When starting up for the first time or after changing the water the device should be switched on only with the cuff connected so that the air can escape from the pump system and the pump does not run dry.

If the pump runs and water is not pumped into the cuff, bleed the pump again.

3.4 Filling and Switching On

- Fill the water reservoir with demineralized water. The fill level indicator should be between the "min" and "max" markings.
- When starting up for the first time or after changing water bleed pump system, see 3.3.
- Plug in mains plug.
- Switch on device with main switch on rear of unit.
After switching on the device performs a self-test. At the end of this self-test an acoustic signal sounds and the menu appears on the display, see 3.9.
- Then connect duo hose and cuff.
- Set to desired temperature setting.
- Press  button.
- Ensure that water is being pumped through the cuff.

3.5 Setting Temperature

- Change temperature settings with  (for higher) and  (for lower).
- The set temperature is stored automatically and the Hilotherapy device changes the actual temperature to the desired values, see temperature value shown in large format in the display.

3.6 Connecting the Cuffs

- Connect the cuff and duo hose with plug-in couplings (audible click when fitting the plug-in nozzles into the couplings).
- The plug-in nozzles on the duo hose can be plugged into the couplings (Fig. 1).
- Do not worry about mixing up the feed and return, this does not lead to malfunctions.
- When putting on ensure that the cuffs are not positioned over sharp edges or other sharp objects.
- Disconnect the cuffs by pulling back on the grip ring.

3.7 Stopping

- Push the  button to stop operation.
- The device can be switched off with the main switch on the rear.
- If the device is not used for longer periods of time, disconnect it from the power supply by pulling out the mains plug.

3.8 Malfunctions

Malfunctions are indicated by a visual error Code shown on the display and an acoustic alarm. The cause of the malfunction is described under Pos 7.4.

3.9 Menu

Switching on device

Main switch on
Device cooling / heating
Pressure pump off

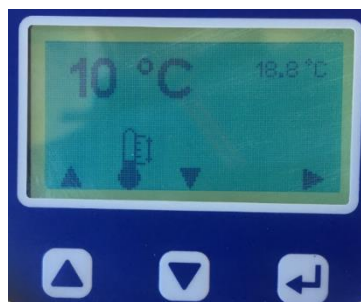

Device in operation

Device cooling / heating
Pressure pump running



The temperature can be changed in both operating states.

Trouble-Shooting

If a malfunction occurs, the letter "E" appears on the display; only the current malfunction code is displayed. The display can be deleted with  (X) only after remedying the malfunction.

Actions for trouble shooting see under Pos 7.4.

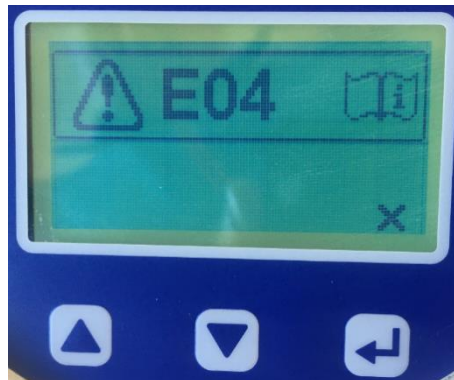

4. Cleaning and Disinfection

4.1 General

Attention! Make sure to disconnect the device from the mains before cleaning!
Do not use sharp objects for cleaning.

4.2 Machine surface

Clean and disinfect the machine's surface and components with such standard detergents and surface disinfectants as are approved for clinical use.

Make sure that no fluids enter the device, in particular through the venting slots on the machine sides.

4.3 Cuffs / Application parts

See chapter 9.7

5. Technical Service, Maintenance, Safety Related Inspections

The Hilotherapy system was developed and manufactured according to the highest quality standards. If the device is used for the intended use and all maintenance is done, the device will reach a lifecycle of 10 years or more.

To ensure the long-term safety and operability of the Hilotherapy system, the following maintenance work should be carried out.

5.1 Replacing the Water Filter and Water Exchange - at least every 6 months

- Remove the grating in the filling hopper using a small screwdriver.
- Remove the filter.
- Pull out the tube of the water level indicator from the casing guide.
- Remove the vent plug.
- Drain the water off completely.
- If necessary, rinse the tank with disinfectant and then rinse it with fresh distilled water.
- Push the outlet tube back into the casing guide.
- Push the vent plug back in.
- Insert the new filter.
- Replace the grating over the filter.
- Fill up above the hopper with distilled water to which a preserving agent, e.g. Ebotec MG, can be added.
- Bleed off the device (see point 3.3).

5.2 Cleaning the Heat Exchanger - at least every 6 months or if contamination is visible

Dust collecting on the heat exchanger will reduce the cooling performance of the device. The heat exchanger is located behind the ventilation grille, on the right-hand side of the device.

- Remove the three Phillips screws on the bottom plate below the ventilation grille.
Attention! Do NOT loosen the hexagon socket screws!
- Lift off the ventilation grille and carefully dust off and clean with a soft brush or vacuum cleaning device.
Attention! The cooling plates on the heat exchanger must not be damaged!

5.3 Greasing the Plug-in Connections - at least every 6 months

The plug-in connections to the tubes must be greased regularly so that they remain easy to plug in and guarantee that the plug-in nozzles in the couplings engage completely.

- Grease the tips of the plug-in nozzles on the cuff and tube thinly using Vaseline.
- Plug the nozzles in and out of the tube or Hilotherapy device couplings. This transfers the Vaseline onto the O-rings in the couplings.

5.4 Technical Service - at least once every 2 years

Visual inspection:

- Are the operating instructions complete?
- Is the type plate complete and legible?
- Are all markings and labelling on the device correct and legible?
- Are all machine components securely attached (no loose parts)?
- Is the machine casing intact?
- Are the plug-in cuff connections intact and easy to use?
- Are all switches and buttons working correctly?
- Does the machine master fuse match the type indicated on the device?
- To change fuses pull out the slot. After changing the fuses push the slot in until it snaps into place.
- Is the device's mains plug with integrated master switch free of defects?
- Is the power cord undamaged?
- Are the device and the accessories kept in a clean condition?
- Are the venting slots and the heat exchanger behind them clean?

- Are the accessories kept in a proper condition?
- Exchange water filter and distilled water.

Functional test:

- Function of the cooling unit (Does it achieve a temp. of + 10 °C?)
- Function of the heating unit (Does it achieve a temp. of + 35°C (+38°C)?)
- Function of the pressure pump (Is there sufficient flow to the cuffs?)
- Can you detect any wear? (Unusual noises?)
- Function of the water level sensor (Water level error message upon switching on the machine with the tank empty?)

In addition, the following inspections can be carried out

- Pressure inspection
- Performance inspections

In case of malfunctions or defects, only put the device into operation again after the problems have been remedied.

Maintenance measures shall only be carried out by qualified personnel. On request, the manufacturer shall support the maintenance personnel with training and technical information.

5.5 Safety Related Inspections

During production, a Safety Related Inspection is carried out within the scope of the final inspection. In order to maintain operational safety, a further Safety Related Inspection must be carried out if repair work is carried out on electrical systems.

5.6 Liability

HILOTHERM GmbH (as manufacturer) only regards itself liable for effects on safety, reliability and operability of this device, if:

- assembly, upgrading, resetting, modifications or repair work is performed by persons authorised by the manufacturer.
- the parts and components used for repair work, modifications, upgrades or local applications are authorized by the manufacturer.
- the wiring being used for the connection of the device complies with the rules and regulations of the local authorities.
- only accessories authorized by HILOTHERM GmbH are used.
- the device is operated in accordance with the operating instructions.

5.7 Warranty

The provisions of the German Law are applicable with respect to warranty for defects.

The provisions of the law pertaining to the product liability law are not affected in this respect.

6. Storage, Transport, Disposal

6.1 Storage

The device should be stored dry and horizontal on a level surface, at a temperature of 5 ° C to 40 ° C and 10 - 70% RH and air pressure of 700 hPa - 1060 hPa.

Caution: If the device is stored below 0 ° C, the water in the cooling circuit must be completely drained to prevent damage from freezing.

6.2 Transport

Before transport, the device must be emptied completely.

Do not tilt the device during transport. If the device is tilted during transport, leave the device standing for 24 hours to regain its full capacity.

Attention: Transport may only take place using a logistics company on pallet as transport via a parcel service often results in the device being damaged.

6.3 Disposal (WEEE Reg. No. DE 25202195)

The device must not be disposed with commercial waste or regular garbage.

In accordance with product responsibility under the terms of § 22 of the German Circular Economy and Waste Act and the Electrical and Electronic Equipment Act § 2, 2 paragraph 1, the device must be disposed of in a communal collecting point or returned to the manufacturer. Please note for disposal that the appliance contains a volume of refrigerant comparable to a refrigerator (refrigerant R134a).

Warning! The compressor unit contains oil.

7. Technical Data

7.1 Technical Data

Type HT02

Article No.	0200 000
Nominal Voltage	230 VAC 50 HZ
Power input	max. 320 VA
Power consumption	2.5 A
Fuse value	T 2.5 A 250 V
Protection class	I
Degree of protection for the application part	B
Type of protection	IP 20
Risk class (93/42 EWG)	IIa
Dimensions	430 mm x 275 mm x 268 mm
Weight	10 kg
Cuff connections	2
Water tank capacity	min. 1.25 litres, max. 2.25 litres
Temperature range	+ 10°C (+5°C) to + 35°C (+38°C)
Accuracy	± 1°C

Cold unit

Nominal voltage	230 V 50 HZ
Working pressure	25 bar inherently safe
Refrigerant	R 134a
Filling quantity	100 g

Pressure Pump

Nominal voltage	15 V
Operating pressure	0.5 bar +0,1

Heating unit









Nominal voltage 230 V
Power input 220 VA

Ambient Conditions

Storage temperature min. + 0 °C, max. + 40 °C
Storage humidity 10 - 70% RH non-condensing
Ambient temperature during operation + 10 °C to + 26 °C
Humidity during Operation 10% - 70% rel. humidity, non-condensing
Environmental Pressure: min. 900 hPa, max. 1100hPa

7.2 Icons

On device and packaging, you will find the following icons:

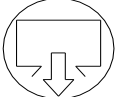
- 
Read operating instructions before starting the device
- 
Manufacturing date (YYYY)
- 
Device type B (Protection against electric shock)
- 
CE Conformity labelling according to EU Directive 93/42/EEC on medical devices with admission authority labelling
- 
No recycling / single use device
- 
Do not dispose of in general industrial or household refuse containers
- 
Warning sign, the device causes temperature changes
- 
filling device
- 
outlet device

7.3 Safety Standards

Classification

Pursuant to the classification criteria stated in the addendum IX EG-RL 93/42 EEC, the Hilotherapy system is a **Class IIa Standard 9** device (active medical product for therapeutical purposes). In terms of the **GMDN** classification, the device is assigned to **No. P 42463**, and the cuffs to **No. P 44604**.

The Hilotherapy system is neither assigned to Attachment 1 nor to Attachment 2 of the MPBetriebV (Medical Devices Operator Ordinance).

Standards and Guidelines

EC-Directive 93/42/EEC of the council on medical products as of June 14, 1993,
 Medical Devices Act as of August 2, 1994
 DIN EN 60 601-1
 DIN EN 60 601-1-2
 DIN EN ISO 10993-1

HILOTHERM GmbH retains the right to change specifications without further notice.

7.4 Malfunctions and Troubleshooting

Error	Possible Cause	Measures
Device does not work, no display readings	1. No mains supply 2. Fuse defect 3. Repeated fuse defect 4. Mains plug not connected 5. Device is defect	1. Switch off device 2. Replace fuse 3. Technical Service 4. Check plug-in connection of the mains 5. Technical Service
No cooling	1. Heat exchanger is blocked with dust 2. Device is defect	1. Clean heat exchanger carefully with vacuum cleaner or a soft brush 2. Technical Service
No or insufficient water circulation	1. Pump has not been vented 2. Tubing or cuff kinks 3. Plug-in coupling is not locked in place 4. Pump is defect	1. Vent the pump, see 3.3 2. Correct positioning 3. Press plug-in couplings together until they lock in position 4. Technical Service
Display reading "E21"	1. Insufficient water in tank 2. Water level indicator arrest	1. Replenish with distilled water 2. Remove water and fill up again
Display reading "E11"	Pump defect	1. Technical Service
Display reading – temperature failure "E01"	Temperature difference between the two temperature sensors detected.	1. Recalibration 2. If 1 not successful call technical Service
Display reading – temperature failure "E02"	Temperature sensors not connected / cable break	1. Recalibration 2. If 1 not successful Repair
Display reading – temperature failure "E03"	Temperature too low < 3°C	1. Recalibration 2. If 1 not successful Check ambient conditions, allow device to warm up
Display reading – temperature failure "E04"	Temperature too high > 42°C	1. Recalibration 2. If 1 not successful Check ambient conditions, allow device to cool down
Display reading – temperature failure "E05"	Increased temperature difference between the two temperature sensors detected.	1. Recalibration 2. If 1 not successful Repair
Display reading – temperature failure "E99"	Control system defect	1. Technical Service
Plug-in connection of the tubing difficult to insert	1. O-ring not lubricated 2. Plug-in connection damaged	1. Lubricate plug-in nozzle with Vaseline 2. Technical Service

In any case of temperature failure E0x a recalibration of the temperature system is useful
 This recalibration is done by pressing all 3 buttons (up, down and enter) during switching on the device. Switch of the device and start it again
Attention! Opening up of the device results in the loss of warranty and liability claims!



8. Accessories and spare parts

Any accessories and spare parts are available at HILOTHERM GmbH or your authorised dealer.

Accessories

Only use original HILOTHERM parts and accessories.

Attention! You must not use any other devices or accessories in combination with the Hilotherapy device.

Standard accessories list

Qty	Article number	Description
1	40000332	Power cord (C, F, 230V 50 Hz)
2	40000259	Duo hose
1	40000379	De-airing set

Spare Parts

Only the use of original spare and replacement parts guarantees the safety and reliability of our device. Parts may only be exchanged by qualified personnel.

The Hilotherapy system is constantly being developed and improved. It is important for you to provide us with the following details so that you will always receive the adequate spare part, even if there have been technical changes.

Name	Typ HT 02	Serial No.
Article No.	HT 02 00 000	Year of manufacture

9. Cuffs

9.1 Variants and Material Properties

Cuffs for thermo-therapeutic applications in anatomically adapted forms:

- Eye cuff
- Eye cuff, open
- Universal cuff
- Nose cuff
- Nose cuff T-cast
- Upper Face cuff
- Lower Face cuff with link
- Lower Face cuff without link
- Round cuff, small
- Round cuff
- Surface cuff, small
- Surface cuff, large
- Knee cuff
- Lower Leg cuff
- Foot cuff
- Hand cuff
- Forearm cuff
- Foot cuff slipper

Due to the continuous development it is possible that certain cuffs are removed from the range while new ones are added to it. A current list is available on the web under www.hilotherapie.com.

Material properties:

Cuff material:	Thermoplastic Polyurethane (TPU) - latex-free
Tubing:	Thermoplastic Polyurethane (TPU)
Plug-in nozzle:	Nickel-plated brass / POM

9.2 Warnings

- The cuffs may only be used in conjunction with the Hilotherapy device.
 - The cuffs must not come into contact with benzene- and phenol-containing chemicals.
 - Before each application of the cuff, check that it is intact (no bubbles, no leakage). Only intact cuffs should be used. When abnormalities occur during the treatment, e.g. Bubble formation or leakage, the application must be aborted immediately. In the case of defects of the hose and the capillary system of the cuffs, these must be discarded.
 - When handling the cuffs, make sure that they are not damaged by sharp objects.
 - Ensure that the flow of the ducts in the cuffs is not prevented by folding the cuffs or by pressing them down.
 - A few drops of water can escape when connecting and disconnecting the hose spouts of the hose system to the Hilotherapy device. Care must be taken that these do not reach wound dressings and dressings! The cuff may be applied only on intact skin or on wound dressings.
 - Eye cuffs must not exert pressure on the eye!

9.3 Fields of Application on the Patient / Specific Function

The cuffs are only intended for external application.

The cuffs are placed on respective skin areas either on top of dressings or directly on intact skin.

The cuffs are used in the treatment and alleviation of injuries, diseases and their after-effects and their mild and constant cold may be applied after operative interventions.

In repeated therapeutical applications we recommend a patient-related allocation of a certain cuff.

Single-use cuffs are for single use only and must not be reprocessed!

9.4 Risk classification of medical products in accordance with RKI guidelines

Risk assessment and evaluation shall be in accordance with Federal Health Gazette No. 44 (2001):

1115-1126: Hygiene Requirements in processing medical products. It is the owner's responsibility that recycling measures are carried out by qualified persons using a suitable and validated procedure.

The individual recycling steps shall be matched to

- the medical product
- the recycling type
- the application on the patient.

The cuffs are only intended for contact with intact skin. Make sure to place wound dressings on pathologically altered skin areas (e.g. abrasions, infective wounds ...) prior to cold treatment.

With regard to the type of application of the cuffs and the related risk, these are classified as **uncritical medical product**.

External application of the cuffs on intact skin (e.g. within the scope of physiotherapeutic and rheumatologic treatments) or on top of a wound dressing (e.g. post-operatively within the scope of plastic surgery, vascular surgery, ENT ...).

9.5 Description of Application

For the individual application on certain body areas, choose a suitable cuff form and connect the cuff to the Hilotherapy device in accordance with the instructions given in the manual (see point 3.6). When connecting or disconnecting the tube plug-in nozzles to the Hilotherapy device, several drops of water may leak from the device. Make sure that these drops do not come into contact with wound dressings and bandages!

When full, place the cuff gently and without exerting any pressure (especially significant for eye cuff use!) on the body parts to be treated. It may be necessary to hold the cuffs in place using strips or bandage.

The duration of the treatment must comply with the orders of the attending physician.

9.6 Storage and Transport

The cuffs are delivered under low-germ conditions, sealed in a transport and dust-protection bag and packed into an outer shipping carton. Make sure to store the cuffs in a dust-free and dry environment at consistent room temperature without UV radiation.

9.7 Disinfection, Cleaning and Drying

Cuffs, devices and accessories are manufactured in a clean and hygienically safe condition and are delivered accordingly. However, the condition of the products mentioned in the delivery state cannot be stated as "sterile"..

9.7.1 Cuffs

Cuffs labeled as single patient use cannot be reprocessed and are only intended for use during treatment on one patient.

Depending on the doctor's instructions, disinfection may be necessary before applying the cuffs to wound dressings or to the area of the body to be treated.

Reprocessing / period of use

Cuffs that are not marked as single-use products can be cleaned, reprocessed and disinfected. This also applies to multiple cuffs that are provided with PU foam insulation on the outer surfaces. If the preparation is carried out properly and depending on the frequency of use, multiple cuffs can be used over a period of about one year.

Due to the frequent use of the multiple cuffs and the reprocessing process, the cuffs are subject to wear due to the application.

Wear-related errors and defects on the cuffs are not subject to any warranty claims

Manual cleaning and disinfection of uncritical medical products

After finishing the treatment, manually clean and disinfect the cuffs with the approved cleaning and disinfectant agents commonly used in clinics (e.g. Kohrsolin FF or Mikrobac by Bode Chemie). Have a qualified person carry out the wiping disinfection (two-bucket-method). Please observe the manufacturer's instructions with regard to concentrations and application time of the disinfection agent. The owner of the Hilotherapy system needs to establish a hygiene and disinfection plan with operational sequence descriptions and operation instructions as part of quality management, so that it is possible to document a traceable and validated recycling process.

Automatic cleaning and disinfection of uncritical medical products

Cleaning, disinfection, rinsing and drying may be carried out in a cleaning and disinfection automat using a validated chemical or chemical-thermal process not in excess of 55 °C.

Fixate the cuff within the device chamber with suitable attachments in such a way that the cuff surface is immersed completely in the cleaning and disinfectant medium. This procedure should immediately be followed by an automatic drying process within the device.

It is important that the automatic procedure is carried out by qualified persons and in accordance with quality management guidelines (operational sequence description, operation and procedural instructions) of the owner.

9.7.2 Basic device

The surface of the equipment consists mainly of ABS plastic and can be ideally treated by wiping disinfection if necessary after selecting a suitable method and disinfectant.

Disinfection of the cooling circuit is not necessary if the maintenance requirements and regular water changes are observed

9.8 Checkup

After successfully cleaning and disinfecting the cuffs, carry out a visual inspection and checkup on the cuffs. If the cuff foil, tubing and / or plug-in nozzles are damaged, the cuff needs to be discharged.

In case of residual dirt, repeat cleaning and disinfection procedure in accordance with the hygiene guidelines (see point 9.7).

Prior to applying the cuff to the patient, the cuff must be attached to the Hilotherapy device and filled up to check for leaks.

9.9 Sterilization

The cuffs cannot be sterilized.

10. Annex Guidelines and Manufacturer's Declaration

A1

Table 1 (IEC 60601-1-2)

1	Guidelines and Manufacturer's Declaration on Electromagnetic Emissions		
2	The HT 02 is designed for use in ambient conditions as described below. The customer or operator of the HT 02 has to make sure the system is being used in such an environment.		
3	Interference emission measurement	compliance	Guideline for electromagnetic environment
4	HF-emissions compliant with CISPR 11	Group 1	The Hilotherapy system uses only HF-energy for its internal functions. Thus, its HF-emissions are very low and it is improbable that it will interfere with the operation of neighbouring devices.
5	HF-emissions compliant with CISPR 11	Class B	The Hilotherapy system is designed for the use in all facilities as well as living quarters, including those facilities connected to a power supply that also serves residential buildings.
6	Emission of harmonic waves compliant with IEC 61000-3-2	Class A	
7	Emission of voltage surges/flickers complying with IEC 61000-3-3	EN 61000-3-3	

A2

Table 2 (IEC 60601-1-2)

Guidelines and Manufacturer's Declaration on Electromagnetic Noise Immunity			
The HT 02 is designed for use in ambient conditions as described below. The customer or operator of the HT 02 has to make sure the system is being used in such an environment.			
Noise immunity checks	IEC 60601 – Test level	Corresponding level	Guidelines for Electromagnetic Environment
Discharge of static electricity (ESD) in compliance with IEC 61000-4-2	± 6 kV contact discharge ± 8kV air discharge	± 6 kV Contact discharge ± 8 kV air discharge	The flooring should be wood, concrete or ceramic tiles. If the flooring consists of synthetic material, relative humidity should at least be 30%.
Rapid transient electrical interferences/bursts in compliance with IEC 61000-4-4	± 2 kV for mains connection ± 1 kV for input and output connections	± 2 kV for mains connection not applicable	The quality of the supply voltage should meet the standards for typical commercial or clinical environments.
Surges in compliance with IEC 61000-4-5	± 1 kV line to line ± 2 kV line to earth	± 1 kV line to line ± 2 kV line to earth	The quality of the supply voltage should meet the standards for typical commercial or clinical environments
Voltage drops, short disconnections and surges of the	< 5% U_T (>95% drop of U_T) for half a cycle	0% U_T	The quality of the supply voltage should meet the standards for typical

supply voltage in accordance with IEC 61000-4-11	40% U_T (60% drop of U_T) for 5 cycles 70% U_T (30% drop of U_T) for 25 cycles 5% U_T (95% drop of U_T) for 5s	40% U_T 70% U_T 5000 mS	commercial or clinical environments. Should the operator of the Hilotherapy system require continued operation in the event of power blackout, we recommend supplying the Hilotherapy system via an interruption-free power supply or battery.
Magnetic field with power frequency at 50/60 Hz in accordance with IEC 61000-4-8	3 A/m	3 A/m	Magnetic fields induced by power frequency should correspond with the values that are typical for commercial or clinical environments.
Footnote: U_T describes the mains AC voltage prior to applying the test levels.			

A3

Table 4 (IEC 60601-1-2)

Guidelines and Manufacturer's Declaration – Electromagnetic Noise Immunity			
The HT 02 is designed for use in ambient conditions as described below. The customer or operator of the HT 02 has to make sure the device is being used in such an environment.			
Noise immunity checks	Noise immunity Test level	Corresponding level	Guidelines for Electromagnetic Environment
Conducted HF-disturbance compliant with IEC 61000-4-6 Radiated HF-disturbances compliant with IEC 61000-4-3	3 V eff 150 kHz to 80 MHz 3 V/m 80 MHz to 2,5 GHz	$U_1 = 3 V$ $E_1 = 3 V/m$	<p>The distance from the Hilotherapy system including its supply lines to any portable and mobile kind of radio equipment should not be less than the recommended protection distance that is calculated from the equation for the transmitted frequency.</p> <p>Recommended protective distance: $d = \left[\frac{3,5}{V_1} \right] \sqrt{P}$ $d = \left[\frac{3,5}{E_1} \right] \sqrt{P}$ for 80 MHz to 800 MHz $d = \left[\frac{7}{E_1} \right] \sqrt{P}$ for 80 MHz to 800 MHz</p> <p>with P as the nominal performance of the transmitter in Watt (W) due to the data given by the manufacturer of the transmitter and d being the recommended protective distance in metres (m).</p> <p>Due to a field survey^a, the field strength of stationary radio transmitters in all frequencies should be less than the corresponding level^b.</p> <p>In the vicinity of devices being marked with the following icon, interferences may occur.</p>

			
Footnote 1: For 80 MHz and 800 MHz, the higher frequency range applies.			
Footnote 2: These guidelines may not be applicable in all cases. The expansion of electromagnetic fields is also affected by absorptions and reflexions of buildings, objects and persons.			
a) In theory, it is not possible to predict the exact field strength of stationary transmitters such as wireless phone base stations, mobile transmitting stations, amateur radio stations, AM and FM broadcasting and television stations. Therefore, a survey of the location should be considered to evaluate the electromagnetic ambient environment with regard to stationary transmitters. If the measured field strength of the location using the Hilotherapy system exceeds the corresponding levels stated above, the device should be closely observed to establish whether it is working as intended. In case the device is observed to have unusual capability features, additional steps may be necessary, e.g. realigning or relocating the Hilotherapy system.			
b) Within the frequency range of 150 kHz to 80 MHz the field strength should be less than [V ₁] V/m.			

A4

Table 6 (IEC 60601-1-2)

Recommended Protection Distances between portable and mobile HF telecommunications devices and the HT 02			
The HT 02 is intended for use in electromagnetic environments with controlled HF disturbances. The customer or user of the HT 02 can positively influence the situation by observing a minimum distance between the HT 02 and portable and mobile HF telecommunication devices (transmitters) – depending on the output power of the communication device (as shown below).			
Power rating of the transmitter W	Protective distance, depending on the transmitting frequency M		
	150 kHz to 80 MHz $d = \left[\frac{3,5}{V_1} \right] \sqrt{P}$	80 MHz to 800 MHz $d = \left[\frac{3,5}{E_1} \right] \sqrt{P}$	800 MHz to 2,5 GHz $d = \left[\frac{7}{E_1} \right] \sqrt{P}$
0.01	0.12	0.12	0.23
0.1	0.37	0.37	0.74
1	1.17	1.17	2.33
10	3.70	3.70	7.37
100	11.70	11.70	23.33
For those transmitters whose power rating is not indicated in the table above, the recommended protective distance d in metres (m) may be calculated using the corresponding equation in the particular column, with P being the maximum power rating of the transmitter in Watt (W) (according to transmitter manufacturer's data).			
Footnote 1: For 80 MHz and 800 MHz, the higher frequency range applies.			
Footnote 2: These guidelines may not be applicable in all cases. The expansion of electromagnetic fields is also affected by absorptions and reflexions of buildings, objects and persons.			



Wittumweg 38, D-88260 Argenbühl-Eisenharz

**EG-Konformitätserklärung für Medizinprodukte
(Anhang II.3 (ohne II.4) MDD)
EC-Declaration of Conformity (Annex II.3 (without II.4) MDD)**

Hiermit erklären wir
We, the undersigned

Hilotherm GmbH
Wittumweg 38
D-88260 Argenbühl-Eisenharz

In eigener Verantwortung, dass nachstehendes Medizinprodukt
Declare on our own authority that the referred medical device below

Produktgruppe /Product Group	Thermotherapie Gerät /Thermotherapy device
Produktbezeichnung /Product Name	HILOTHERM Clinic / HILOTHERM Clinic
Produkttyp /Product Type:	HT02 / HT02
Klassifizierung nach MDD / Classification according MDD	Klasse IIa / Class IIa

den grundlegenden Anforderungen der nachfolgenden Richtlinie entsprechen
comply with the essential requirements of the following directive

**Medizinprodukte Richtlinien 93/42/EWG
Medical Device Directive 93/42/EC**

Gekennzeichnet durch
marked with



Benannte Stelle / Notified body:
TÜV SÜD Product Service GmbH
Ridlerstraße 65
D-80339 München

Hilotherm bestätigt ebenfalls das Einhalten folgender Richtlinie
Hilotherm also confirms the compliance to following directive

RoHS II

Diese Konformitätserklärung hat Gültigkeit bis zur Änderung geschriebener Inhalte dieser Erklärung
The declaration is valid until the change of any contend of the declaration

Eisenharz, 2020-02-12

ppa. Klaus Janisch

Konformitätserklärung Clinic HT02_ 2020-02-12